

PEEL TESTER

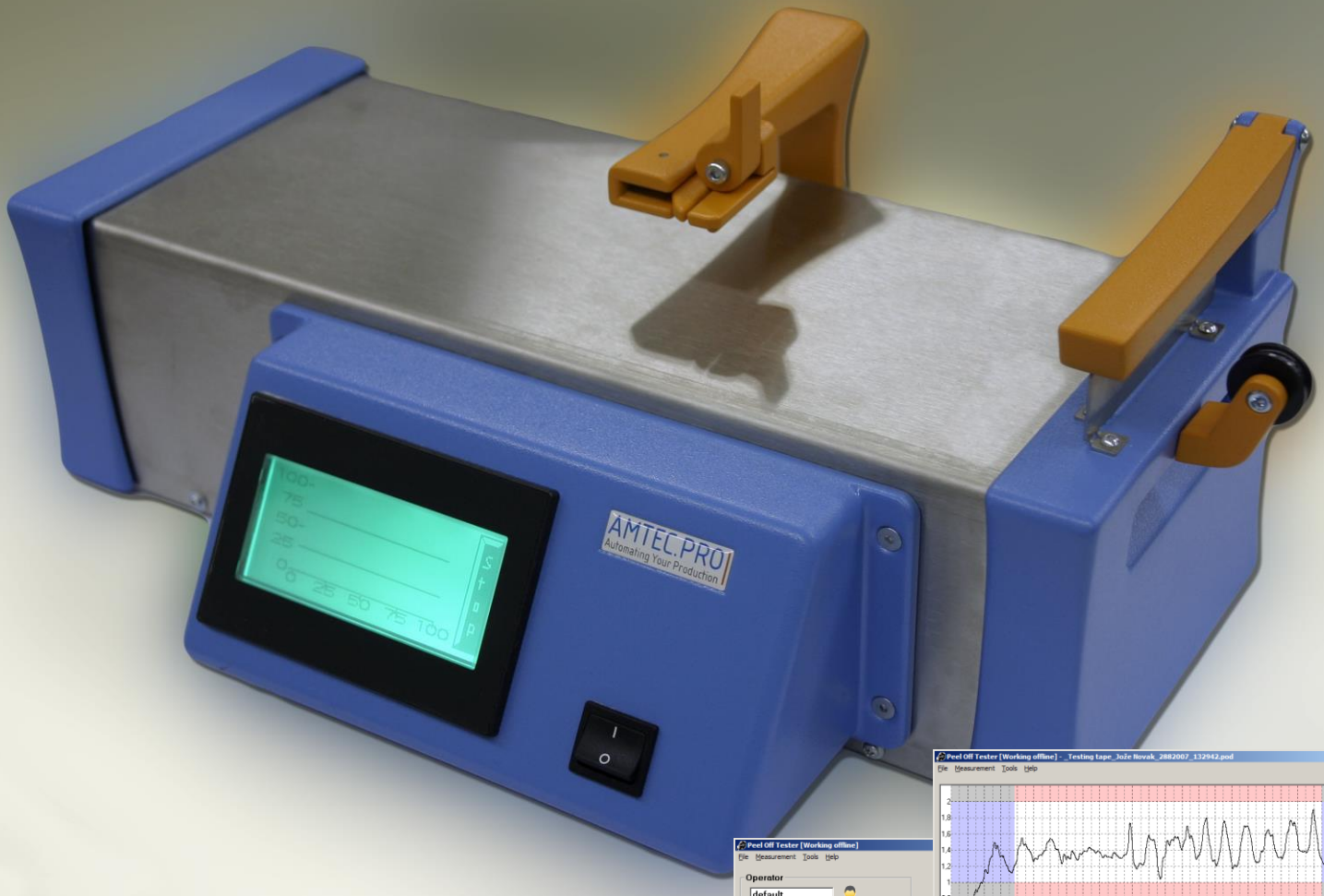

Regular peel force testing is crucial to control production process.

Off-line operation mode allow users to make the test and get immediate result response trough three color display.

Quality management can retrieve all measurements from device trough Ethernet connection for reporting or controlling the process. A total traceability of measurements from one hand.

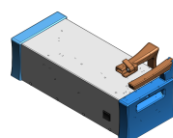
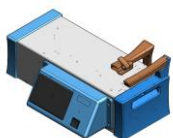
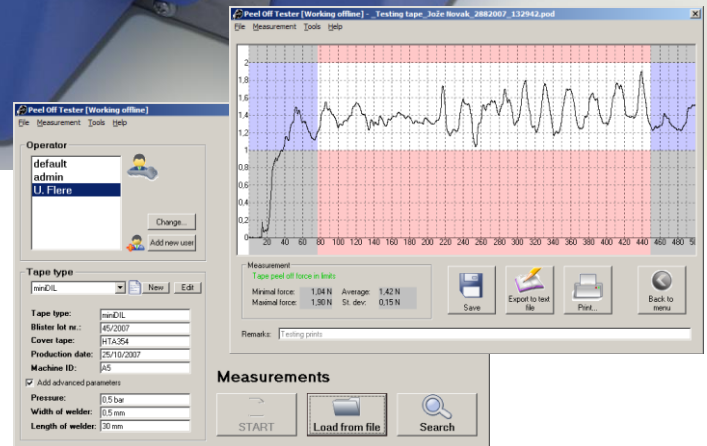

Touch Screen Operation

Measurement setup and start trough touch screen.

Three colour screen signaling machine state or measurement status:

- Green – normal operation / test passed OK
- Orange – setup
- Red – malfunction / test passed NOK

Setup menu provide settings as:

- Test parameters
- Measurement limits
- ... and many more ...



Holding Lever

Holding lever can be lifted up to allow operator easy placing of carrier tape sample.

Height of the holding plate is adjusted to maximum pocket depth 25mm, other dimensions on request.

Cover Tape Holding Lever

Easy cover tape fixing with eccentric lever.

Moveable joint eliminates clamping irregularities.

Overload protection.

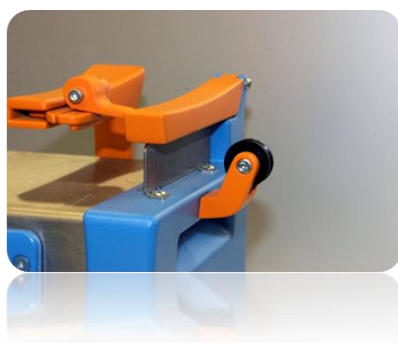

Calibration Wheel

Device is supplied internally pre-calibrated.

Regular calibration can be done with the calibration weight set.

Yearly recalibration according to ISO 17025 is available.

Software

Multifunctional software package with allow user to browse between stored data, set user rights, download measurement options and tape data as lot of other options.

Supports both Off-Line or On-Line mode.

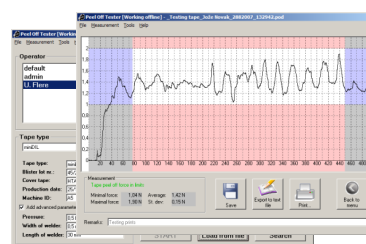

Technical specifications

Peel test according EN 60286-3:2007

Tape width:	8-200mm
Max pocket depth:	40mm
Measuring range:	0-3N (other on request)
Resolution:	0,01N
Measurement tolerance:	$\pm(0,02+2\%)N$
Electrical supply:	230VAC, 2A
Weight:	3kg

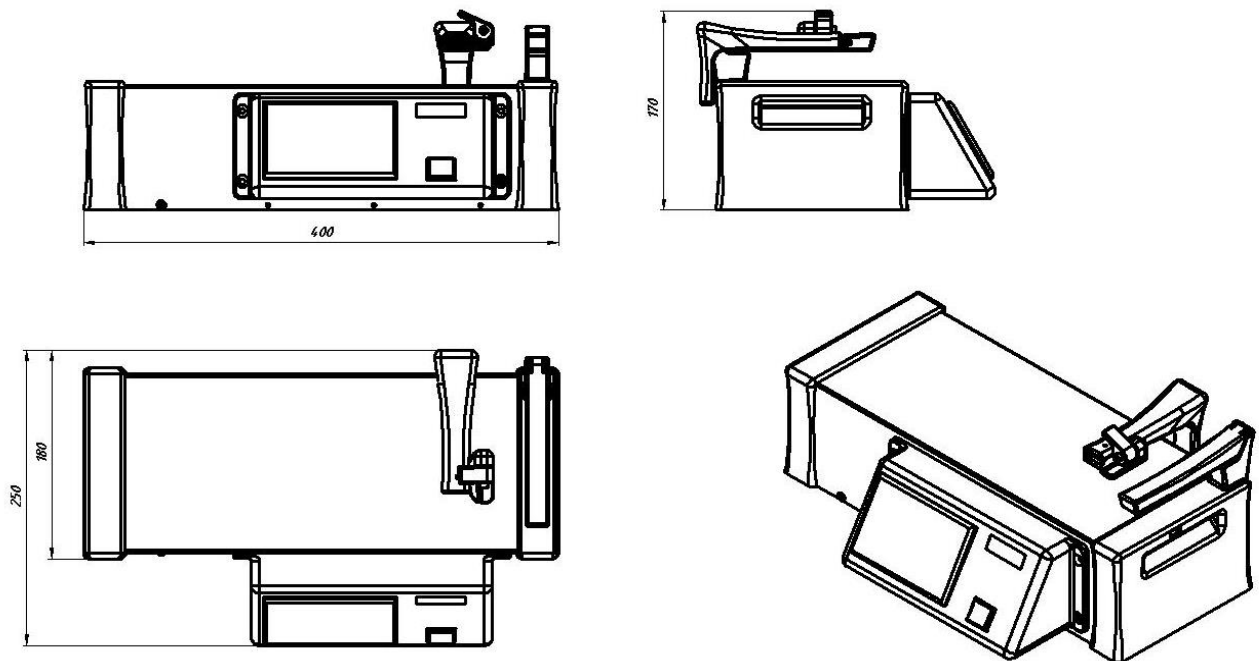

ORDER SPECIFICATIONS

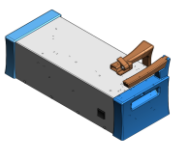

Art. No. 931001
 Basic

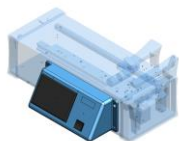

Art. No. 932001
 Off-Line



Art. No. 933001
 Calibration set [g]



Art. No. 933003
 Calibration set [N]



Art. No. 933002
 Calib. certificate